

CEM



CEM



CEM



CEM

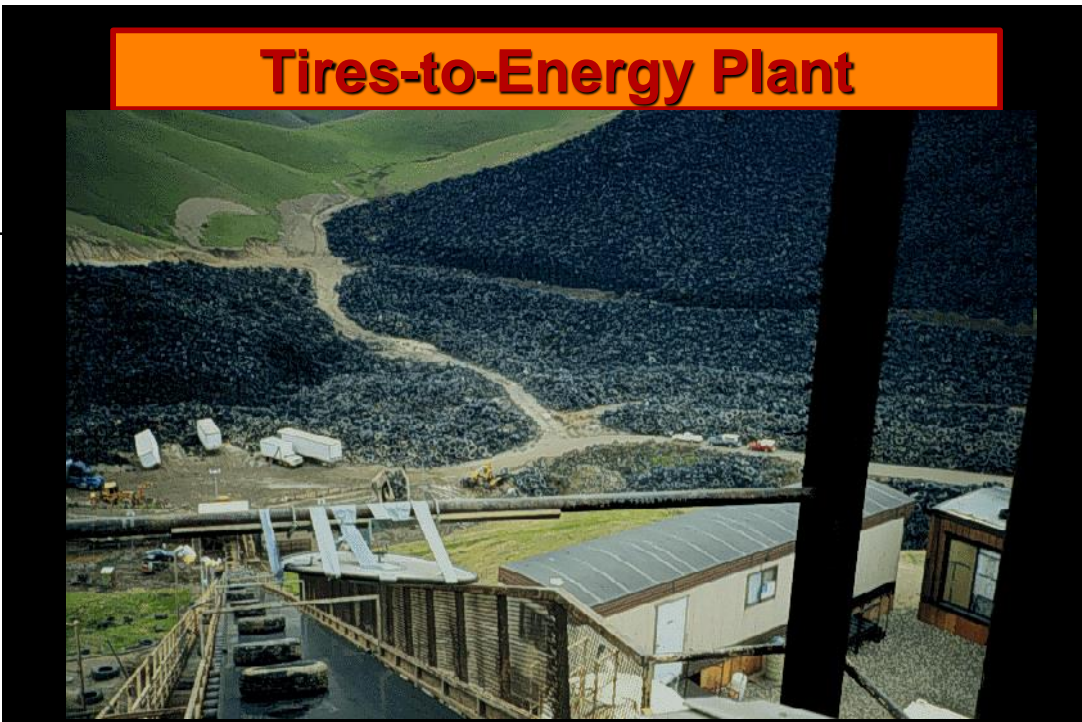

CEM



CEM

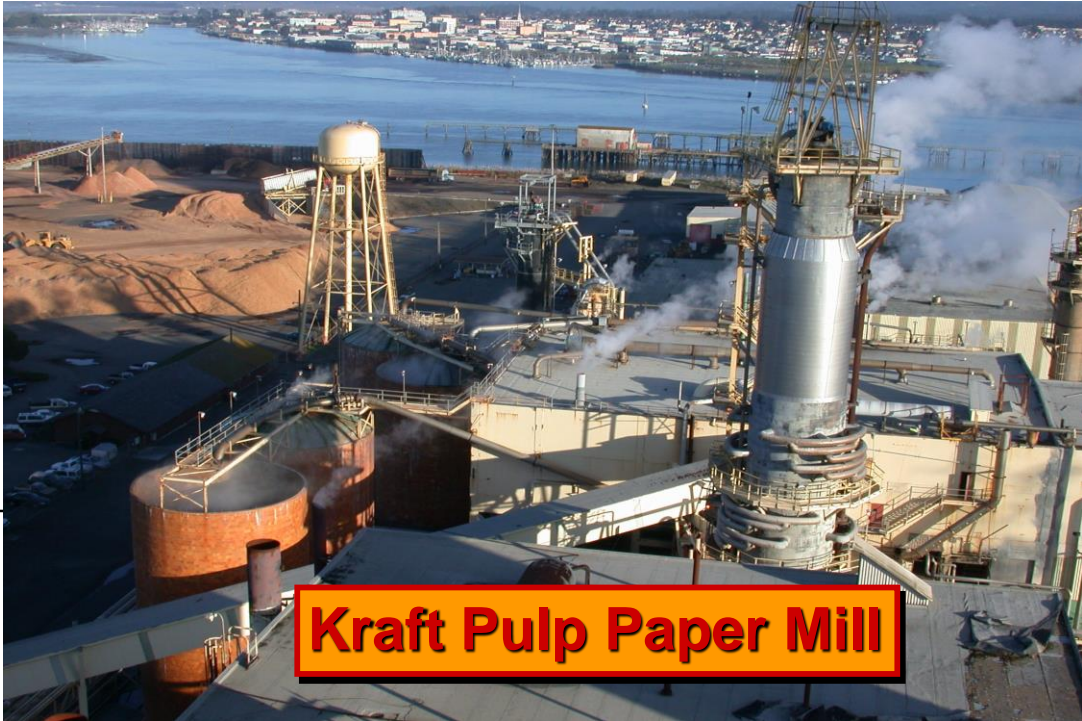

Kraft Pulp Paper Mill



Opacity Transmissometer

CEM

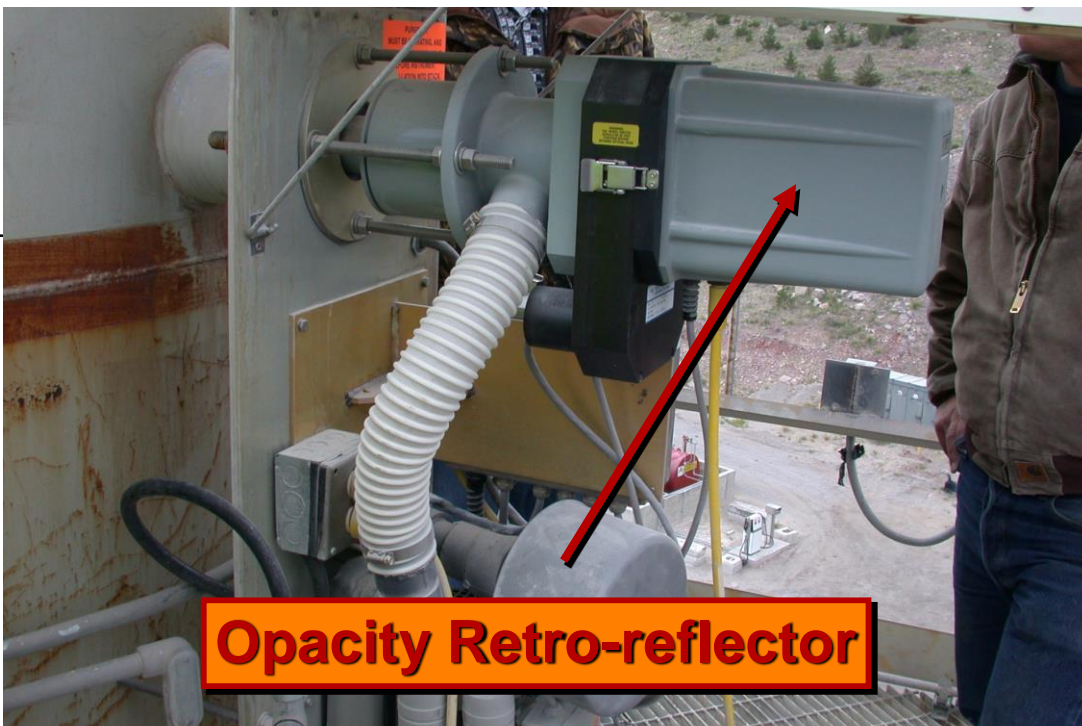
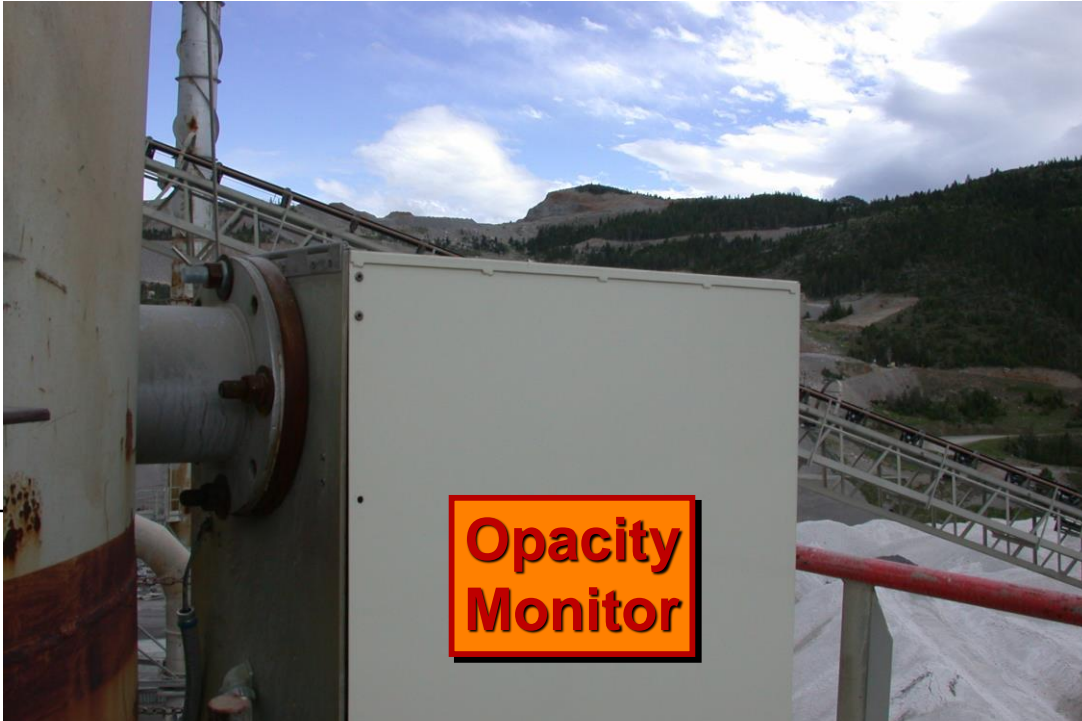

CEM



CEM

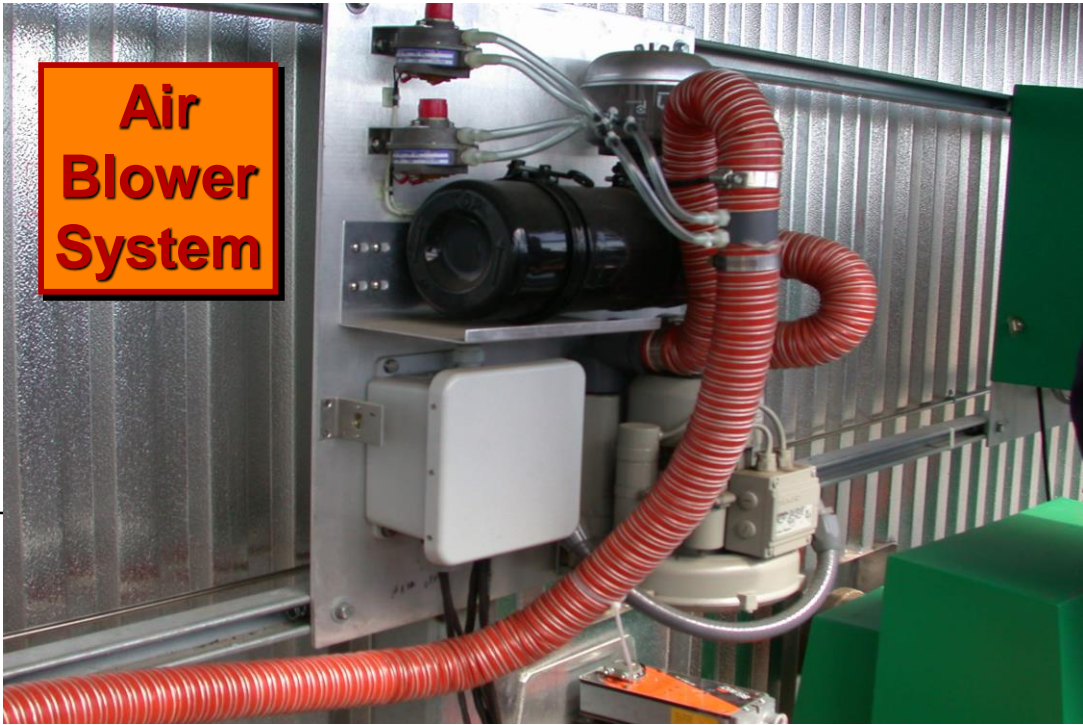

CEM



CEM



CEM

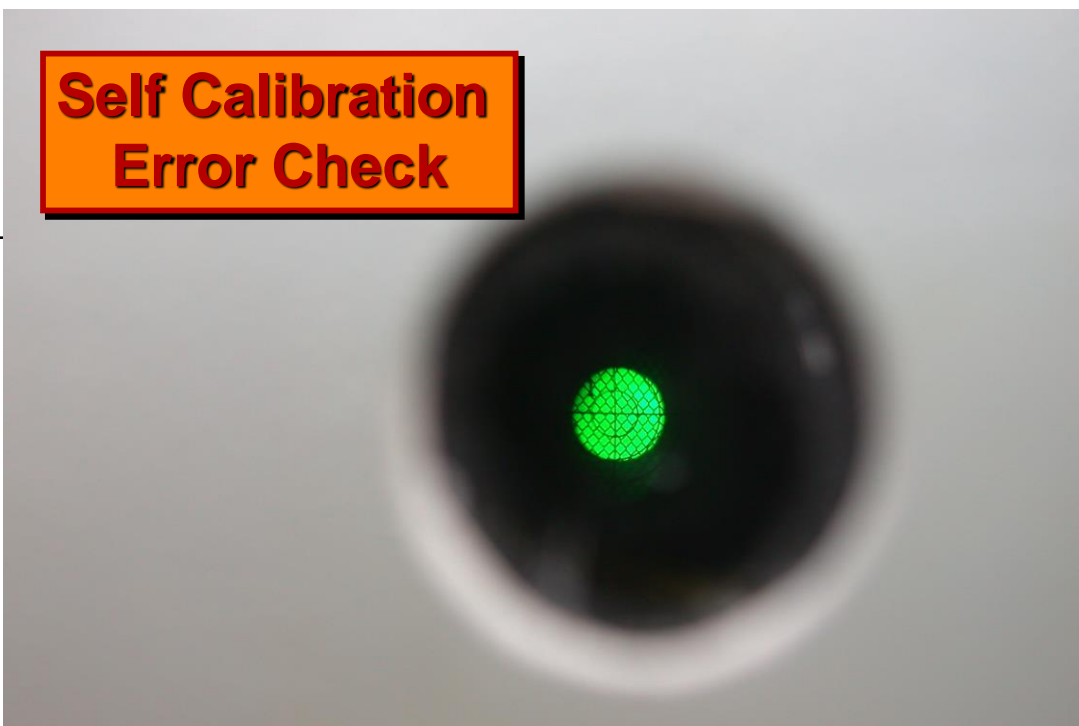
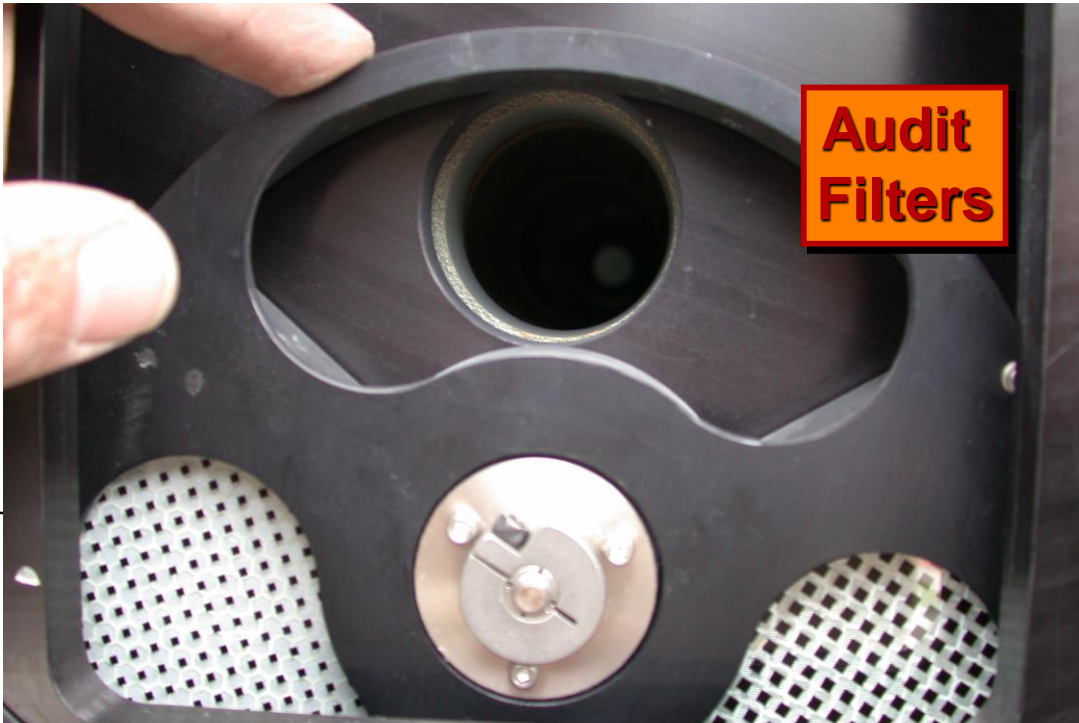

CEM

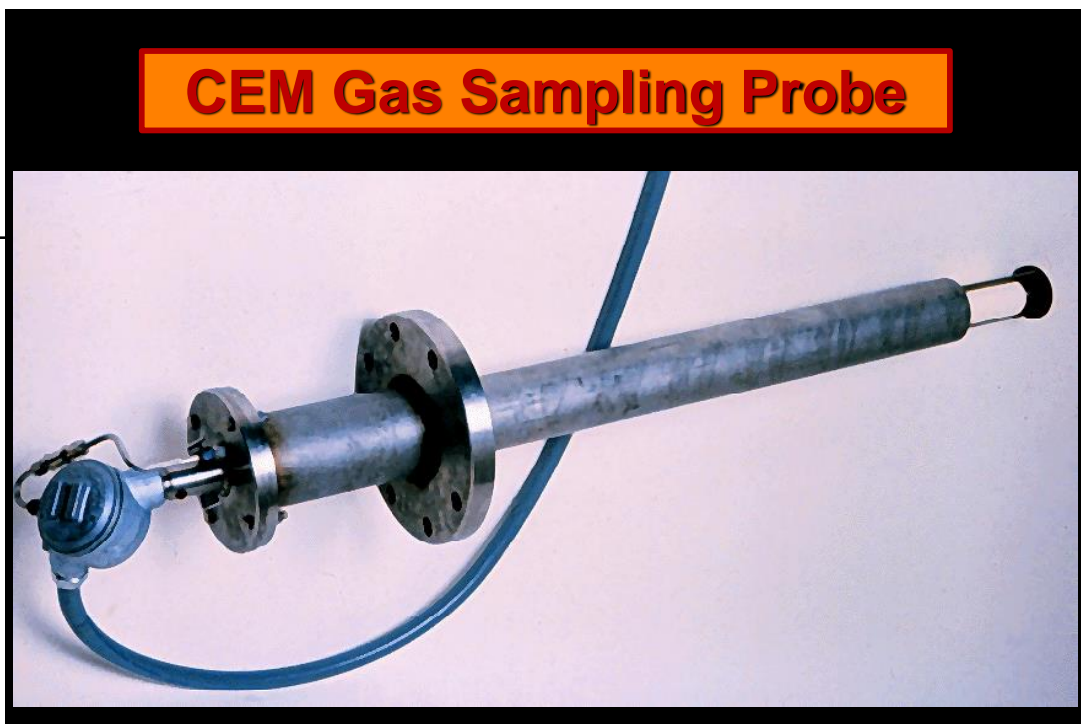
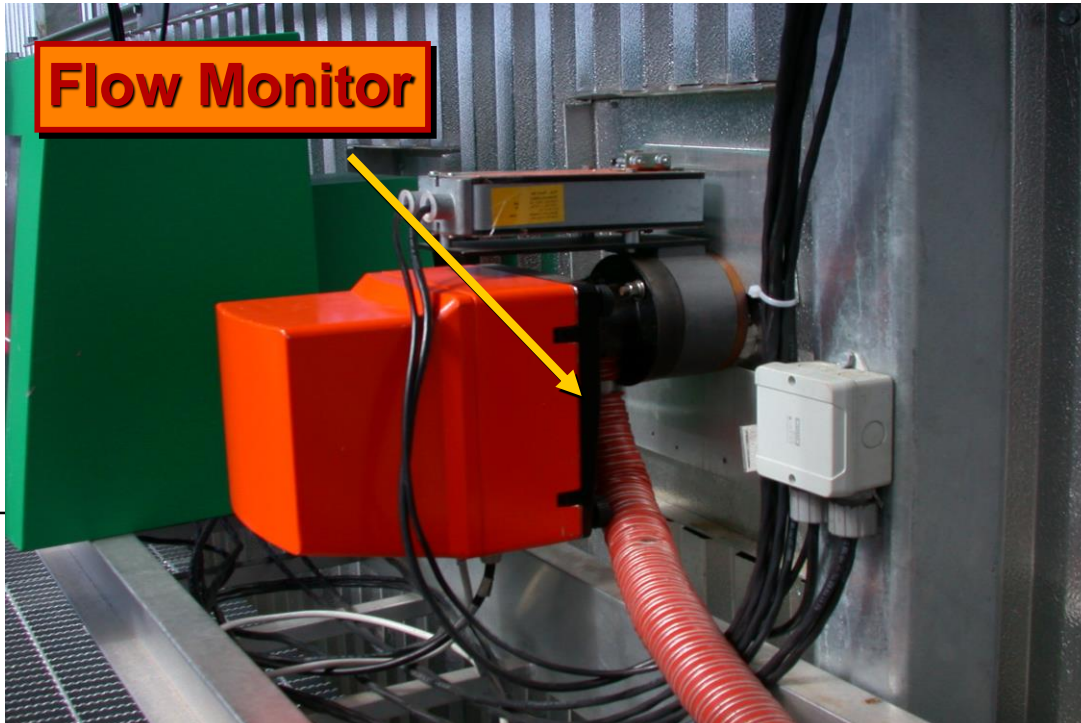

CEM

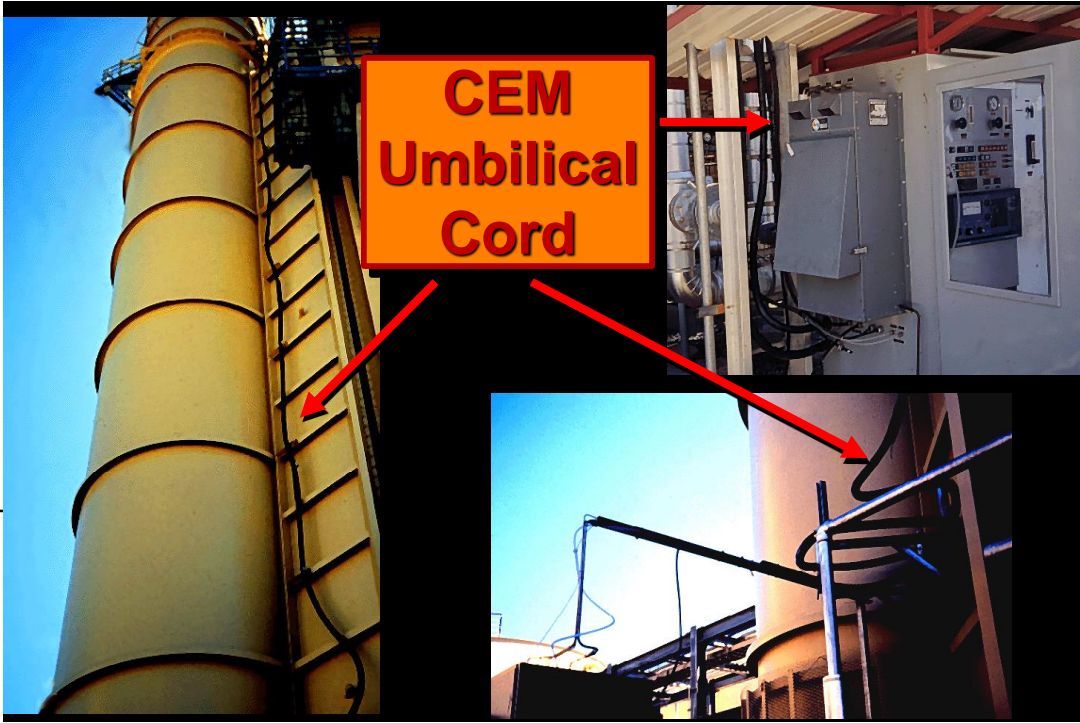

CEM

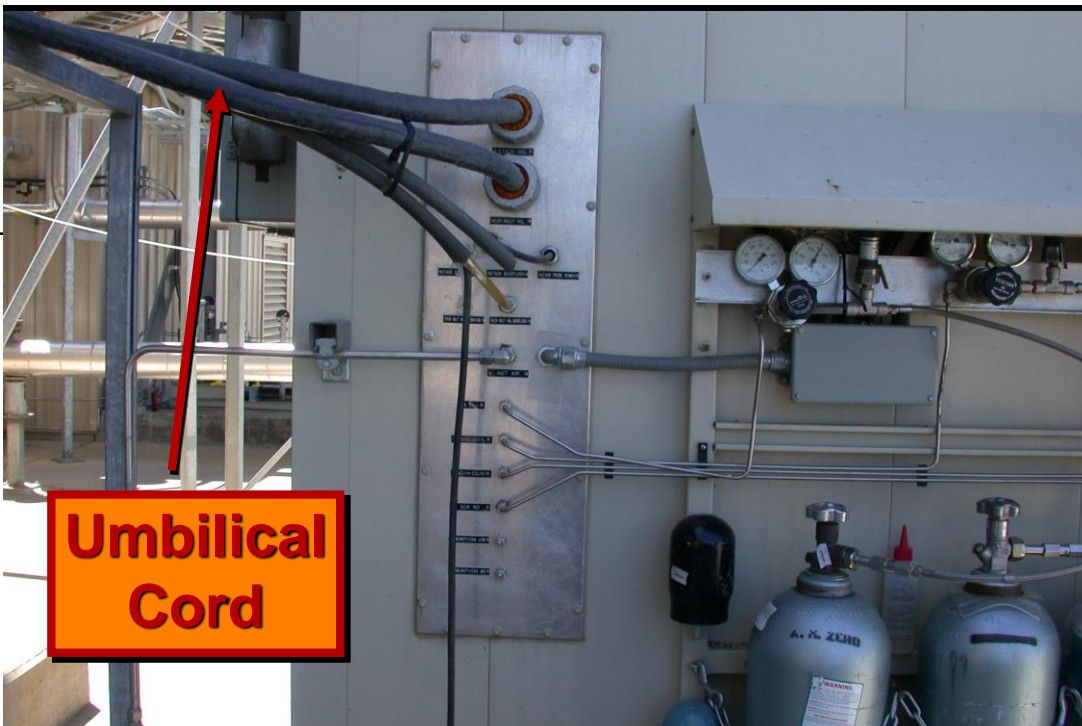

CEM

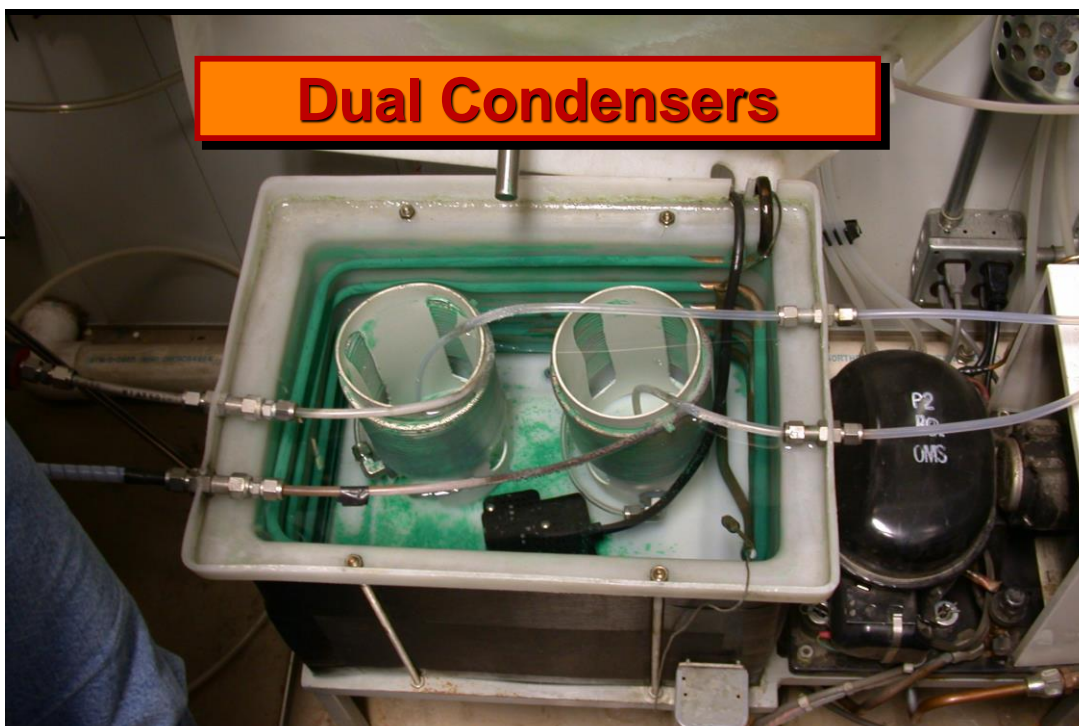

Jet Stream Condenser

Sample flue gas

Dry gas to analyzer

Coolant

To condensate trap

Photo courtesy of M & C Products USA

Jet Stream Condenser

Perma Pure Permeation Dryer

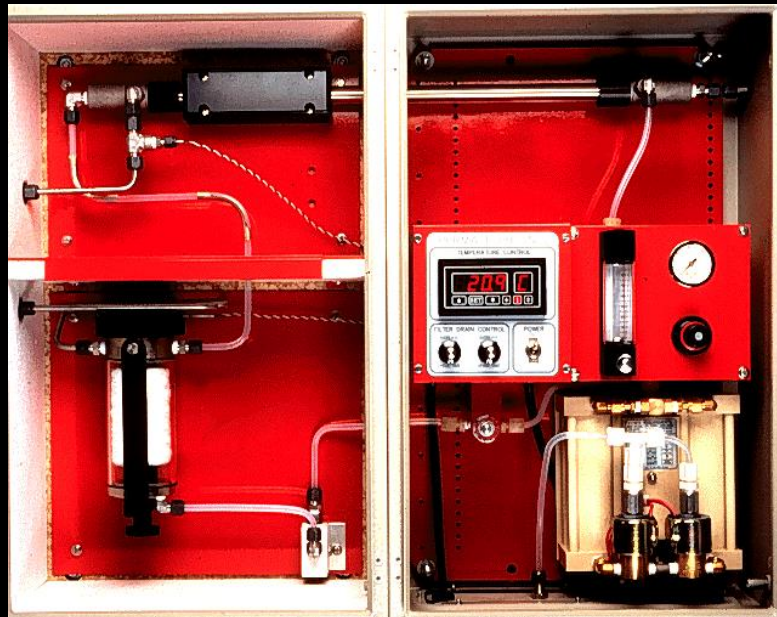

Diaphragm Pump

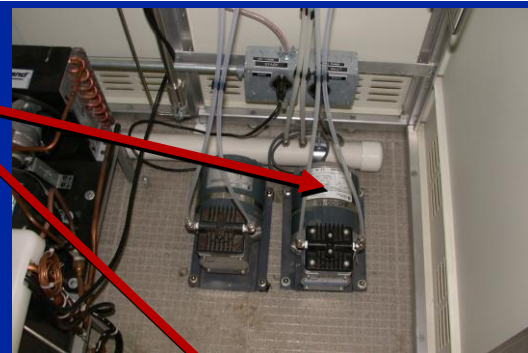
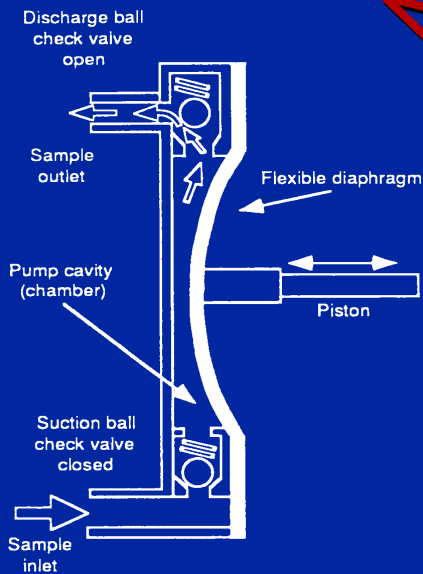

CEM

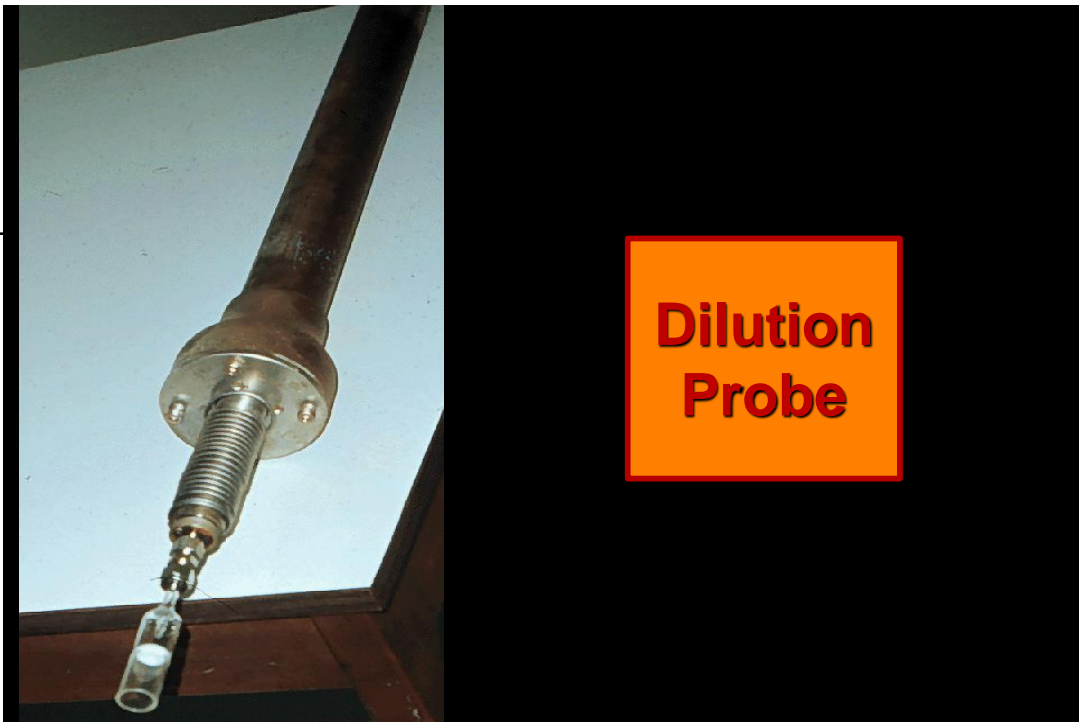
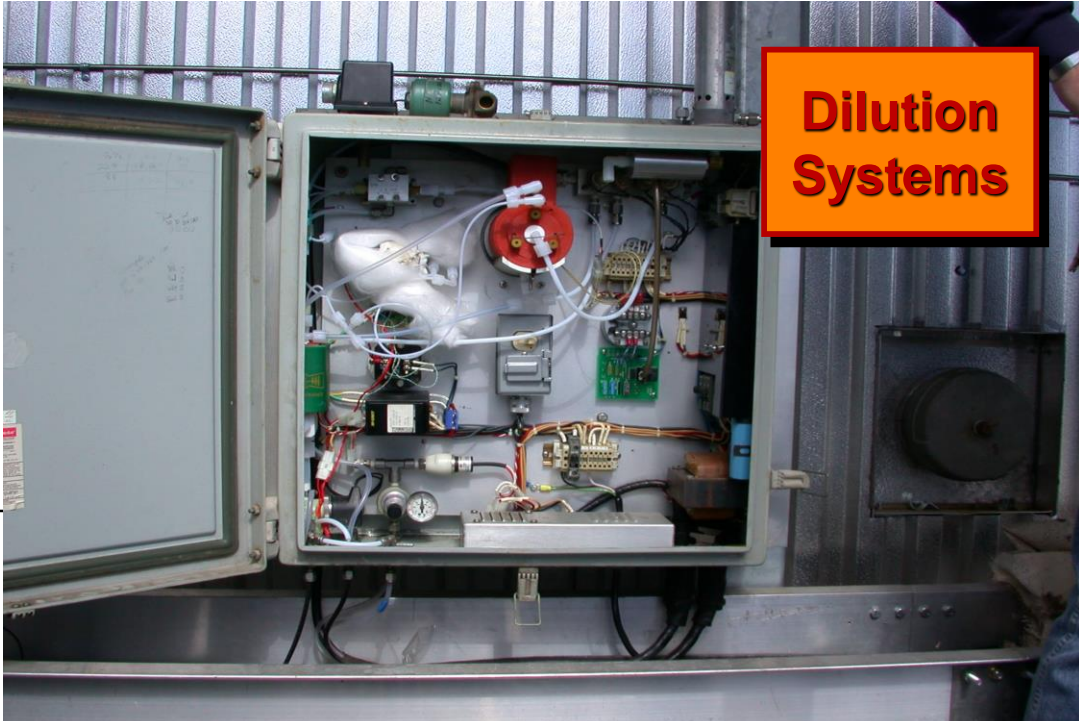

CEM



CEM

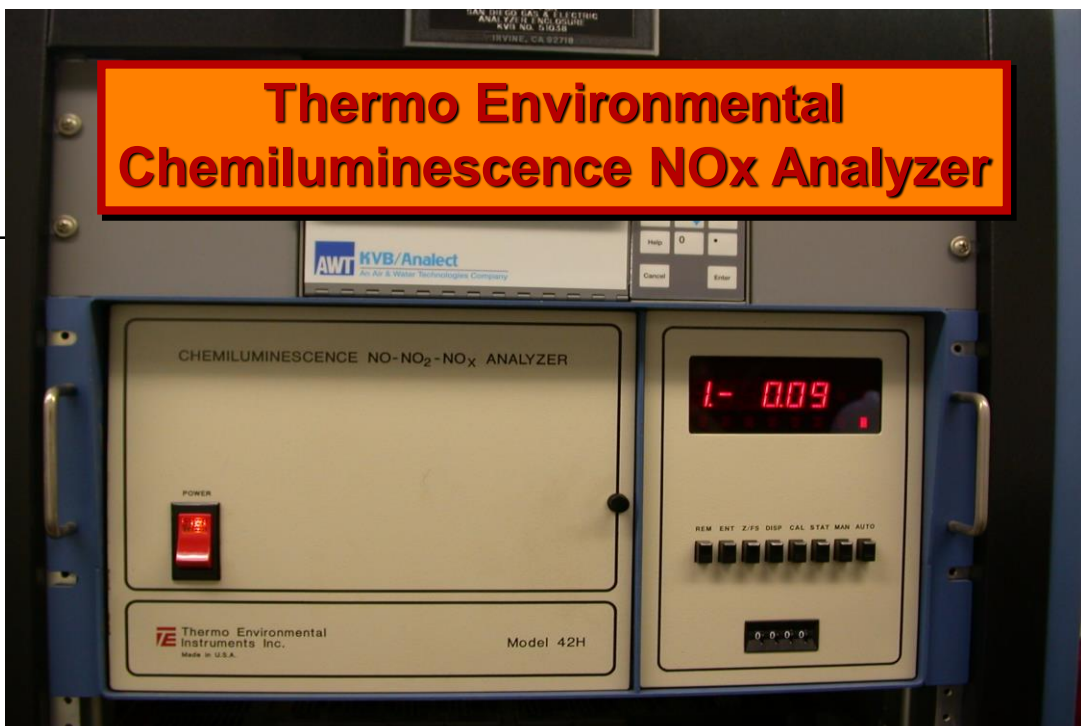

CEM

Bendix Hydrocarbon Analyzer

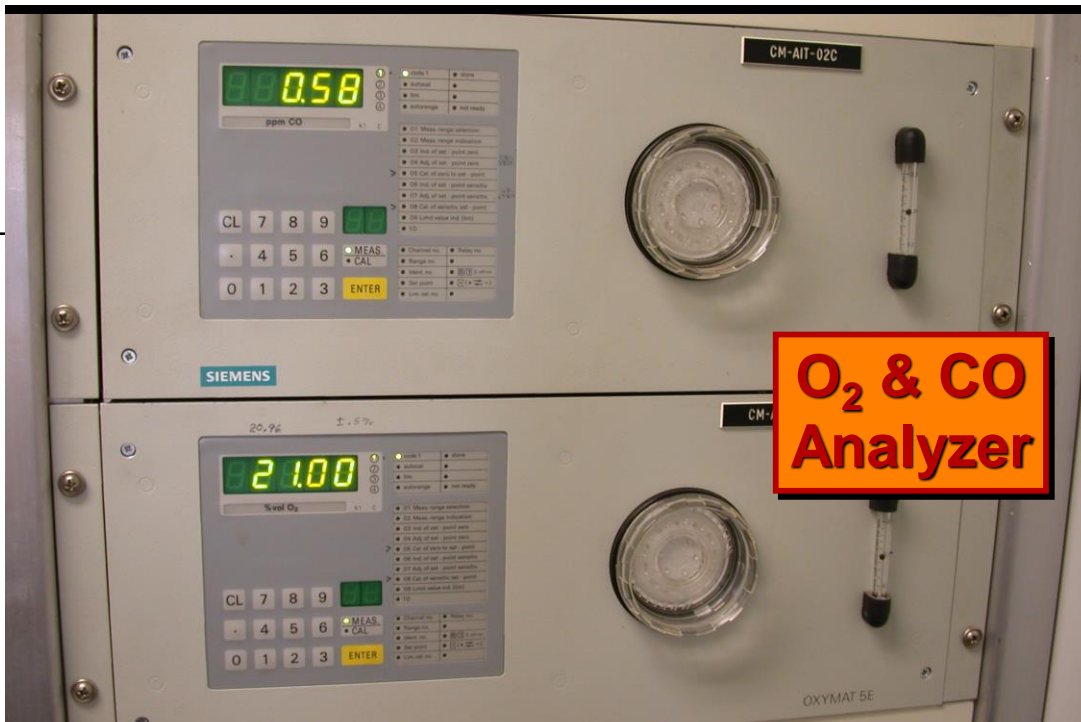
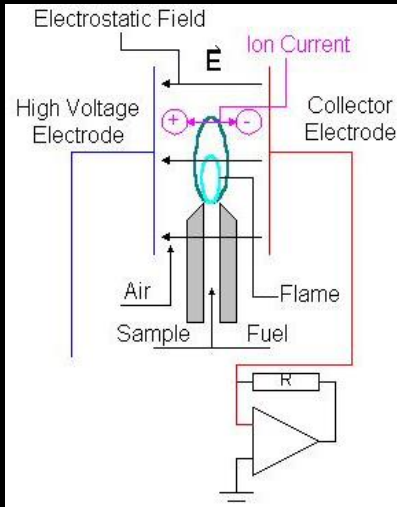

CEM



CEM

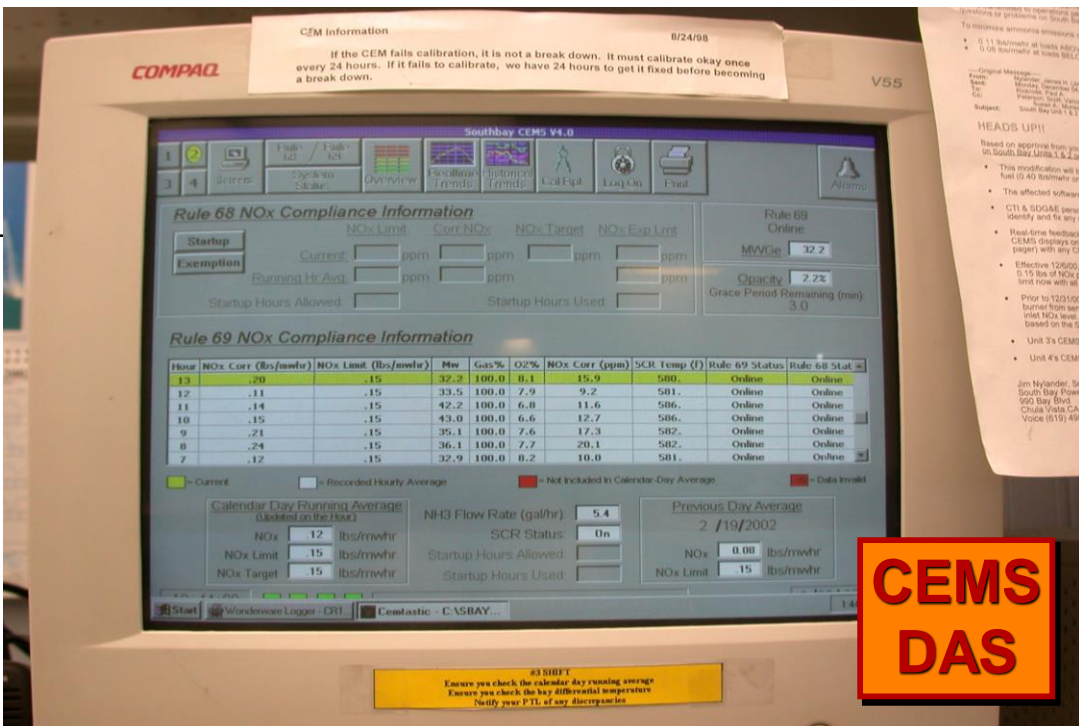
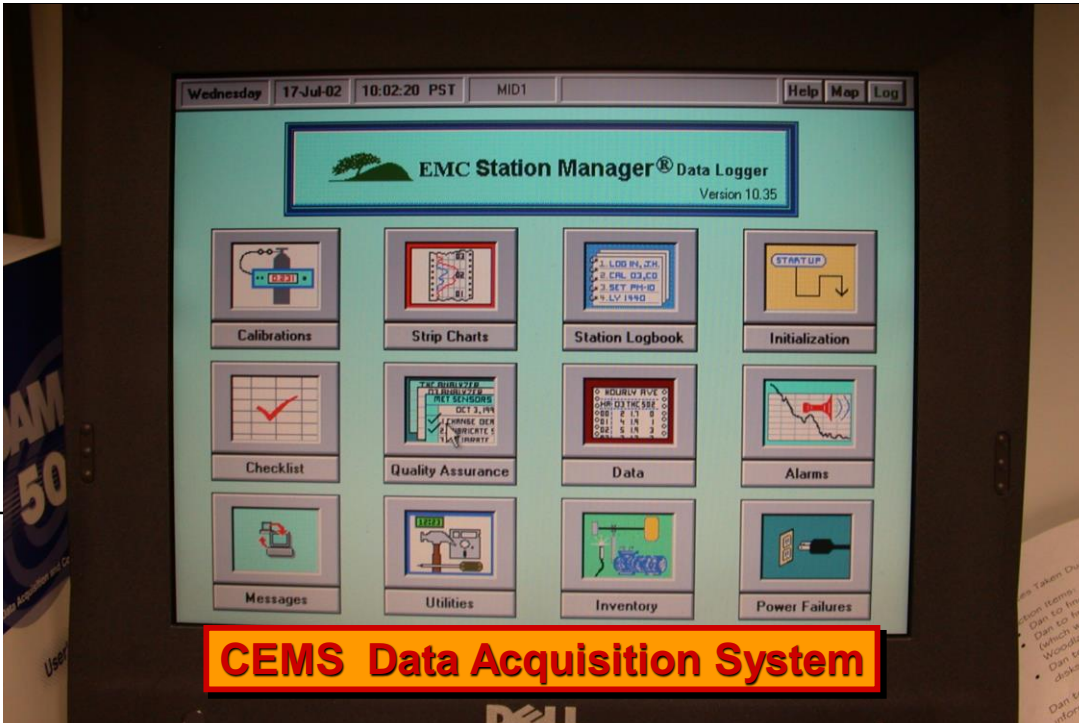

CEM

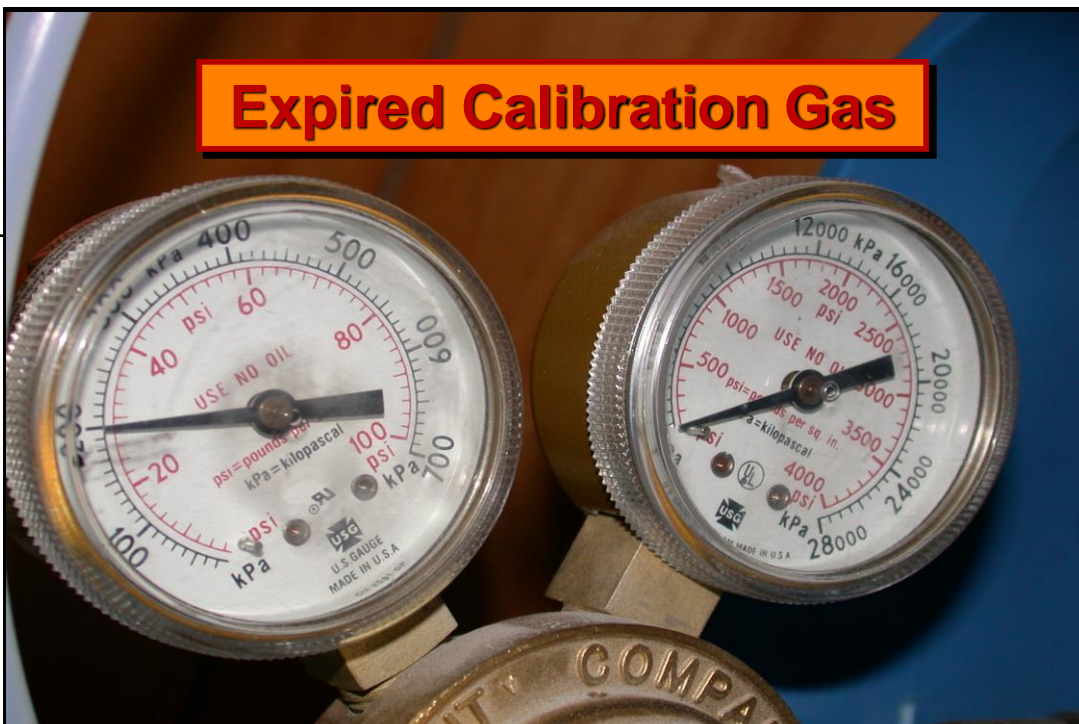

CEM



CEM

